

TERRA 6 HPLA

MONOVALENT HEATING SYSTEM WITH BRINE AS HEAT SOURCE

ORDER NUMBER: 265010

SERIES: M2

TF MAX. 65 °C

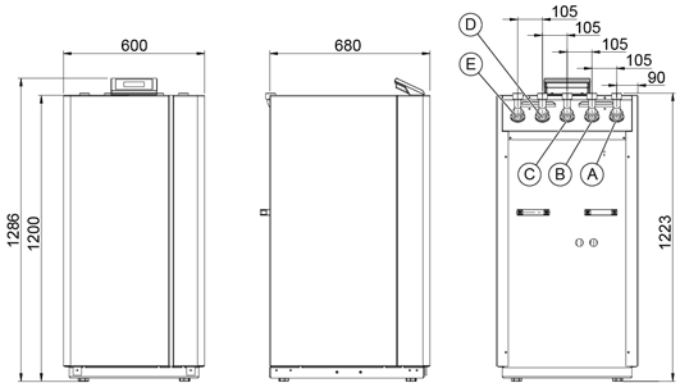

(A) FLHC (outlet) (B) FLT (outlet) (C) RTN (inlet) (D) WQA (outlet) (E) WQA (inlet)

APPLIANCE DATA

Dimensions HxWxD	[mm]	1285x600x681
Hydraulic connection	[inch]	1 1/4"
Weight	[kg]	200
Casing colour		White/anthracite

SPECIFICATION

Phases/nominal voltage/frequency	[~]/[V]/[Hz]	3/400/50
Output factor cos φ		0,72
Fuse protection (tripping curve "C")	[A]	16
Max. operating current	[A]	4,80
Max. starting current/max. with soft start	[A]	28.00 / 14.00
Sound power/sound pressure level (at 1 m distance)	[dBA]	43.00 / 35.00

HEATING MODE PERFORMANCE FIGURES (to EN 14511)

Standard point B0/W35		
Heating output	[kW]	5,80
Total power consumption / operating current	[kW]/[A]	1.20 / 2.40
COP		4,80
Operating point B0/W50		
Heating output	[kW]	5,30
Total power consumption / operating current	[kW]/[A]	1.70 / 2.90
COP		3,10
Operating point B0/W60		
Heating output	[kW]	5,00
Total power consumption / operating current	[kW]/[A]	2.00 / 3.20
COP		2,50

CONDENSER

Type		Plate heat exchanger
Material		Stainless steel 1.4301
Max. refrigerant operating pressure	[bar]	45
Max. heat transfer medium operating pressure	[bar]	6
Heat transfer medium temperature differential	[K]	5
Application range	[°C]	65
Heat transfer medium		Water
Test pressure	[bar]	54
Heat transfer medium flow rate	[m³/h]	1,00
Internal pressure differential	[mbar]	113
Flow meter (FM)	Internal	Installed as
Circulation pump heat sink (WNA)	Internal	Yonos Para HPS 25/7.5
Residual head I WNA external	[mbar]	656

REFRIGERANT CIRCUIT

Refrigerant		R410A
Refrigerant charge	[kg]	1,4

COMPRESSOR

Type		Scroll
Output levels		1
Speed	[rpm]	2900
Voltage/frequency	[V]/[Hz]	400/50

EVAPORATOR

Type		Plate heat exchanger
Material		Stainless steel 1.4301
Number	[pce]	1
Max. heat transfer medium operating pressure	[bar]	6
Max. refrigerant operating pressure	[bar]	12
Heat transfer medium temperature differential	[K]	3
Application range	[°C]	-5/+20
Heat transfer medium		Brine max. 30%
Test pressure	[bar]	54
Heat transfer medium flow rate	[m³/h]	1,45
Internal pressure differential	[mbar]	-
Flow meter (FM)	Internal	Installed as
Circulation pump heat source (WQA)	Internal	Stratos Para 25/1-8
Residual head I WQA external	[mbar]	589

Hydraulic version			Electric immersion heater		3-way switching module	
			Internal	external	Internal	external
M2-1	M4-1		x		x	
M2-2	M4-2			x	x	
M2-3	M4-3		x			x
M2-4	M4-4	M6		x		x

RECOMMENDED ACCESSORIES

	Order no./type	Description	Pressure loss
Heat pump buffer tank	min. PU300	30 l/kW at B0/W35	-
DHW tank	min. SP300/SP350	30 l/kW at B0/W50	-
External plate heat exchanger (DHW heating)	911251 PHE 2007	Prim.: 1" Sec.: 1"	Prim.: 37 mbar Sec.: 71 mbar
3-way switching module internal	980202	-	-
3-way switching module external	290229	DN32 (1 1/4"). kvs 16	4 mbar
Electric immersion heater internal	980201	8.8 kW (2.9 / 2.9 / 2.9)	-
External electric immersion heater (heat pump buffer tank)	922507	3 kW	-
Brine collector set (shallow laying)	290166	ESK 3	54 mbar incl. brine distributor

EXTRACTION CAPACITY ACC. TO VDI 4640

FOR SHALLOW LAYING

Soil conditions	Max. spec. extraction capacity at 1800 h/a	Max. spec. extraction capacity at 2400 h/a
Dry, non-cohesive soil	10 W/m ²	8 W/m ²
Cohesive soil, moist	25 W/m ²	20 W/m ²
Water-saturated soil with sand/gravel	40 W/m ²	32 W/m ²

FOR DEEP TRENCH LAYING

Soil conditions	Max. spec. extraction capacity at 1800 h/a
Cohesive soil, moist	100 W/m deep trench
Water-saturated soil	125 W/m deep trench

FOR GEOTHERMAL PROBES

Soil conditions	Spec. extraction capacity at 1800 h/a	Max. spec. extraction capacity at 2400 h/a
Dry sediment	25 W/m	20 W/m
Shale, slate	45 W/m	35 W/m
Firm rock with high thermal conductivity	84 W/m	70 W/m
Substratum with high groundwater flow	65-80 W/m	55-65 W/m

SIZING RECOMMENDATION WITH BRINE AS HEAT SOURCE

Pressure loss in connection line, incl. individual losses	Max. 100 mbar
Pressure loss in brine circuits or probes, incl. brine distributor	Max. 300 mbar

PERFORMANCE CURVES TERRA 6 HPLA

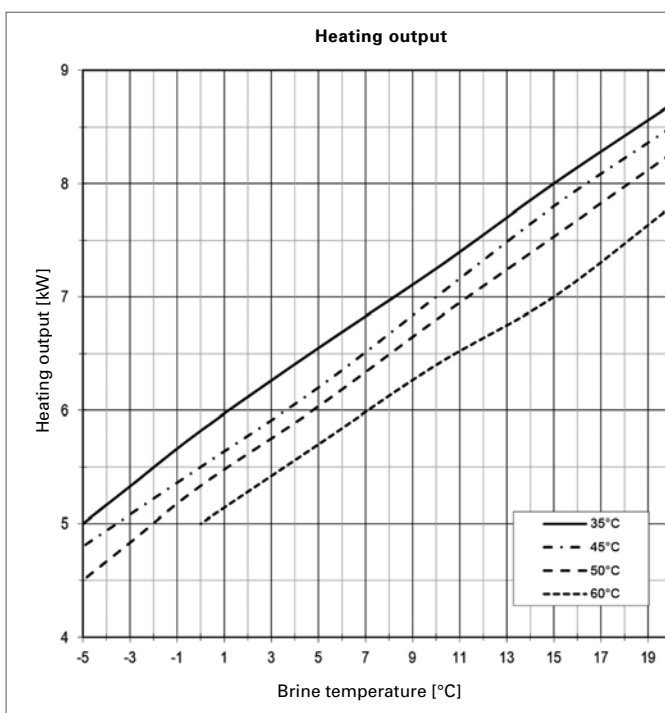

PRODUCT DATA ErP: TERRA 6 HPLA

	COLDER	MEAN	HOTTER
LOW TEMPERATURE A+++		35°C	
ηs	208	199	195
Energy consumption [kWh]	2656	2330	1536
P rated [kW]	6	6	6
SCOP	5,40	5,16	5,06
MEDIUM TEMPERATURE A++		55°C	
ηs	136	131	129
Energy consumption [kWh]	3551	3087	2031
P rated [kW]	5	5	5
SCOP	3,61	3,48	3,42
DHW A		SP300	
ηWH	88	88	88
Energy consumption [kWh]	1621	1621	1621
Draw-off profile		XL	
Tank losses [W]		94	
	indoor	outdoor	
Sound power level [dBA]	43,0	-	
Controller class with room remote control	VII	Controller contribution [%]	3,5
Controller class without room remote control	III	Controller contribution [%]	1,5

